



SERIE 14 - ART. A002

SERIE 15 - ART. A004



SARACINESCA A TENUTA METALLICA - CORPO PIATTO / CORPO OVALE PN10-PN16
METAL SEATED GATE VALVE - SHORT / LONG BODY PN10-PN16

APPLICAZIONE:

Fornitura, raccolta, distribuzione di acqua, reti per la raccolta e deflusso acque di scarico, sistemi fognari.

APPLICATION:

Supply, collection, distribution of water, networks for the collection and discharge of waste water, sewage systems.

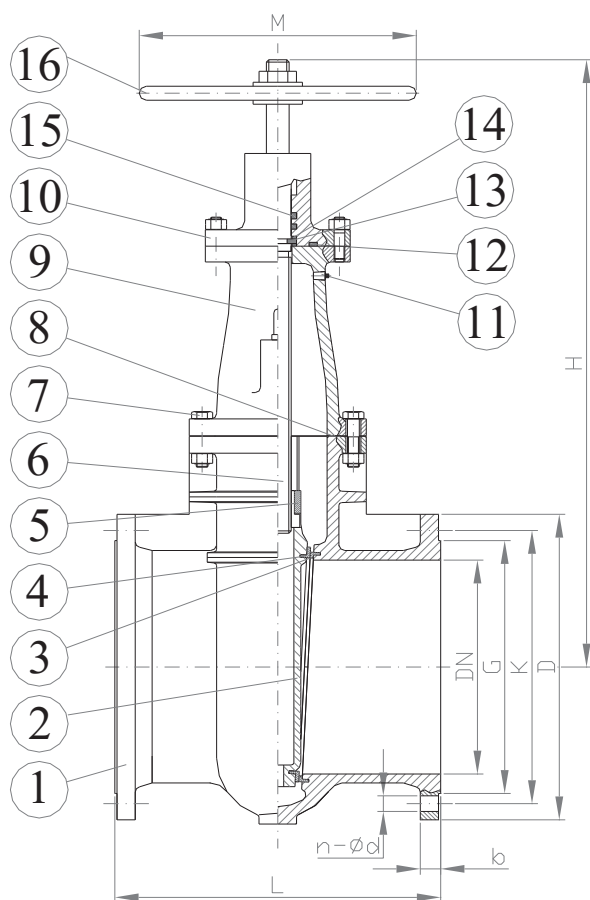

Disponibile anche con **RIDUTTORE**
 Available also with **GEAR BOX**

CARATTERISTICHE PRINCIPALI - MAIN FEATURES

NORMA PROGETTO:	EN 1171 EN 1074-1 ed EN 1074-2
SCARTAMENTO:	EN 558 Serie14-15
FLANGE:	EN 1092-2
COLLAUDI:	EN 12266-1
TEMPERATURA ESERCIZIO:	Max. +90°C
DESIGN STANDARD:	EN 1171 EN 1074-1 and EN 1074-2
FACE TO FACE:	EN 558 Series14-15
FLANGES:	EN 1092-2
TESTS:	EN 12266-1
WORKING TEMPERATURE:	Max. +90°C

	COMPONENTI - PARTS	MATERIALI - MATERIALS
1	CORPO BODY	EN-GJS 500-7 EN-GJS 500-7
2	CUNEO WEDGE	EN-GJS 500-7 EN-GJS 500-7
3	ANELLO DI TENUTA SEALING RING	BRONZO BRONZE
4	ANELLO DI TENUTA SEALING RING	BRONZO BRONZE
5	MADREVITE STEM NUT	BRONZO BRONZE
6	ASSE STEM	ACC. INOX AISI 420 (EN 1.4021) SS AISI 420 (EN 1.4021)
7	VITE E DADO BOLT AND NUT	ACCIAIO ZINCATO 8.8 GALVANIZED STEEL 8.8
8	GUARNIZIONE GASKET	EPDM EPDM
9	CAPPELLO BONNET	EN-GJS 500-7 EN-GJS 500-7
10	COPERCHIO COVER	EN-GJS 500-7 EN-GJS 500-7
11	TAPPO PLUG SREW	EN-GJS 500-7 EN-GJS 500-7
12	O-RING O-RING	NBR NBR
13	COLLARE SPINDLE COLLAR	EN-GJS 500-7 EN-GJS 500-7
14	BOCCOLA BUSHING	BRONZO BRONZE
15	O-RING O-RING	EPDM EPDM
16	VOLANTINO HANDWHEEL	EN-GJS 500-7 EN-GJS 500-7

DN	PN	G	K	D	L		H	M	n-ød	b	W (kg)	
					S14	S15					S14	S15
350	10	429	460	505	290	550	980	600	16-23	24.5	320	371
350	16	429	470	520	290	550	1012	600	16-28	26.5	320	371
400	10	480	515	565	310	600	1070	600	16-28	24.5	418	459
400	16	480	525	580	310	600	1123	600	16-31	28	418	459
450	10	530	565	615	330	650	1154	600	20-28	25.5	560	620
450	16	548	585	640	330	650	1237	600	20-31	30	560	620
500	10	582	620	670	350	700	1250	600	20-28	26.5	707	777
500	16	609	650	715	350	700	1332	600	20-34	31.5	707	777
600	10	682	725	780	390	800	1421	600	20-31	30	979	1172
600	16	720	770	840	390	800	1478	600	20-36	36	979	1172

RIVESTIMENTO - COATING

Esterno/interno con polvere epossidica di colore blu RAL 5015 e spessore 250µm.

External/internal FBE coating process with epoxy resin powder of blue colour RAL 5015 and thickness of 250µm.